

i70 Transducer Calibration

Transducer calibration

The transducers listed in the table below can be calibrated using the i70 multifunction instrument display.

Transducer type	Connection
Depth transducers	connected via iTC-5 or Depth pod
Speed and temperature transducers	connected via iTC-5 or Speed pod
Wind transducers	connected via iTC-5 or Wind pod
Smart transducers	connected directly to SeaTalk ^{ng}
Fluxgate compass	connected via iTC-5
Rudder reference	connected via iTC-5

Depth calibration

Depth Offset

Depths are measured from the transducer to the sea bed, but you can apply an offset value to the depth data, so that the displayed depth reading represents the depth to the sea bed from either the keel or the waterline.

Before attempting to set a waterline or keel offset, find out the vertical separation between the transducer and either the waterline or the bottom of the keel on your vessel, as appropriate. Then set the appropriate depth offset value.

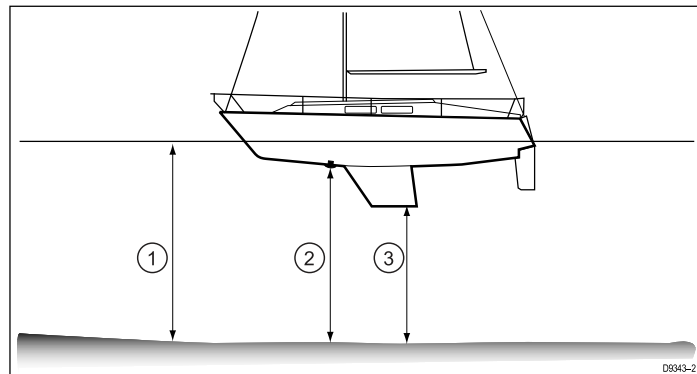

1	Waterline offset
2	Transducer / Zero offset
3	Keel offset

If an offset is not applied, displayed depth readings represent the distance from the transducer to the sea bed.

Setting the depth offset

The depth calibration consists of setting a Depth Offset that is relevant to your depth transducer's installed location.

From any favorite page:

1. Select **Menu**.
2. Select **Set-up**.
3. Select **Transducers Set-up**.
4. Select **Continue**.

The instrument display will search for and display a list of connected devices. (i.e. iTC-5, DST or transducer pod)

5. Select the device that the transducer(s) you are calibrating are connected to.

A list of available transducer data is displayed,

6. * Select **Depth**.

Note: * Step only applicable to iTC-5.

7. Select **Depth Offset**.

8. Select **Depth From:**

A list of transducer offsets is displayed:

- Waterline
- Keel
- Transducer (default)

9. Select the location that you want depth measurements to be taken from.

After selection the Depth Offset page is displayed. If you have selected Waterline or Keel a Depth Offset must be applied.

10. Select **Offset:**

11. Use the **Up** and **Down** buttons to adjust the Depth Offset to the required value.

The offset value should be the same as the measured distance:

- from the transducer face to the Waterline, or
- from the transducer face to the bottom of the Keel.

12. Select **Save**.

Setting an incorrect Depth Offset could lead to your vessel running aground.

Speed calibration

Speed transducer calibration is required as transducer performance is affected by a number of variables such as transducer location, shape of the hull and water flow characteristics. The purpose of performing Speed calibration is to ensure that the speed readings at the instrument are a true indication of the vessel's actual speed.

In order to achieve accurate results, speed calibration must be carried out in calm conditions with zero tide and zero current.

Speed calibration aligns the instruments log speed (Speed Through Water) to:

- Speed Over Ground (SOG), or
- a referenced speed

Calibrating using SOG

For most installations a 1 Point Speed Calibration is all that is required.

If the 1 point calibration does not provide sufficiently accurate readings or you require a higher level of precision for your speed readings then a Speed Run Calibration can be carried out. It is advisable to carry out the Speed Run Calibration at as many speeds as possible. This is particularly important for planing vessels.

* Conventional speed transducers have a maximum of 5 calibration speeds, and smart transducers (e.g. DST800) have up to 8.

If required each calibration point can also have a calibration factor applied to further align the log speed reading across different vessel speeds.

Note: * The Speed Run Calibration cannot be performed when the transducer is connected to a Speed Pod.

Calibrating without SOG

For most installations a 1 Point Speed Calibration is all that is required. The calibration must be performed using a way of estimating actual vessel speed and adjusting the displayed reading so that the log speed matches the your estimated speed.

If you do not have SOG data available then the Speed Run Calibration cannot be performed.

If required, further calibration points can be added and a calibration factor can be applied to further align the log speed with actual vessel speed.

	iTC-5		Smart (DST)		Speed pod	
	SOG	No SOG	SOG	No SOG	SOG	No SOG
1 point speed calibration	✓	✓	✓	✓	✓	✓
Speed run calibration	✓	✗	✓	✗	✗	✗
Manual calibration	✓	✓	✓	✓	✓	✓

1 Point Speed Calibration

For most installations a 1 Point Speed Calibration is all that is required.

Prerequisites:

- For best results SOG data should be available, or an alternative method of estimating vessel speed must be used (e.g. vessel speed can be estimated using [Nautical Measured Mile Markers](#) or similar landmarks of a known distance apart).
- You will need to be underway, with sufficient space to maneuver unhindered.
- In order to achieve accurate results, water conditions must be calm with zero tide and zero current.

From a favorite page:

1. Select **Menu**.
2. Select **Set-up**.
3. Select **Transducers Set-up**.
4. Select **Continue**.

The instrument display will search for and display a list of connected devices. (i.e. iTC-5, DST or transducer pod)

5. Select the device that the transducer(s) you are calibrating are connected to.

A list of available transducer data is displayed,

6. * Select **Speed**.

Note: * Step only applicable to iTC-5.

7. Select **Speed Calibration**.
8. Select **Adjust speed up/down**.

The 1 Point Speed Calibration page is displayed.

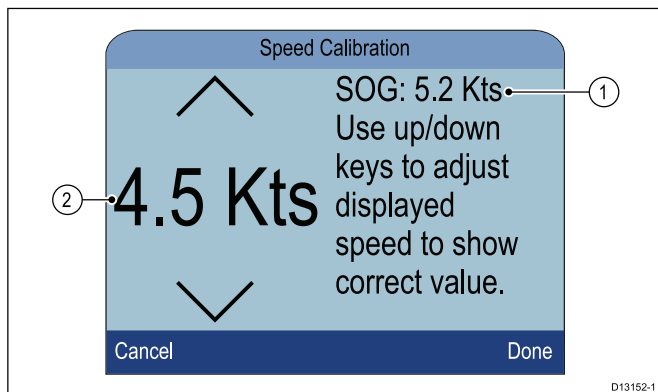

1. SOG speed reading
2. Current speed reading

If SOG is not available then the SOG value will display dashes.

9. Accelerate your vessel to a steady, typical cruising speed.
10. Use the **Up** and **Down** buttons to adjust the current speed reading so that it matches the SOG reading or matches your estimated speed.
11. Select **Done** when both values are the same.

The calibration complete page is displayed.

12. Select **Ok**.

If you experience significant deviation between SOG and log speed readings at different vessel speeds then a Speed Run Calibration should be performed. Refer to the [Performing a Speed Run Calibration using SOG](#) section for details.

Nautical measured mile markers

When neither SOG data or any other reliable means of estimating Speed Through the Water (STW) is available, Nautical Measured Mile Markers can be used to help calibrate Log Speed. Nautical measured mile markers are identified by two pairs of posts or towers. The distance between each pair of markers is 1 nautical mile.

Each marker in a pair is separated by distance and elevation from its partner. The front marker is closer to the water and shorter than the marker behind it.

Markers — side view

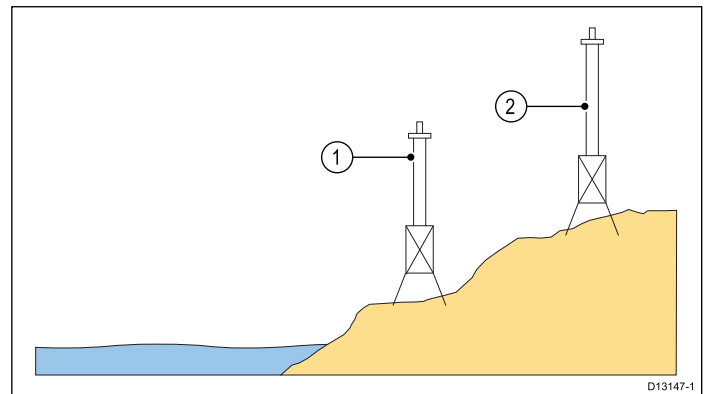

1. Front marker
2. Rear marker

When the 2 markers appear vertically aligned the vessel is on the correct range line to begin a measured mile run.

Marker alignment

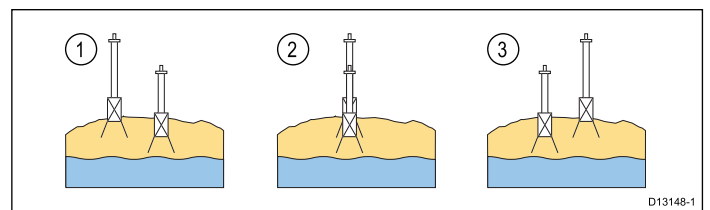

1. Left of range line
2. On range line
3. Right of range line

The vessel should already be at top speed and as the first pair of markers appear aligned a stopwatch should be started, when the vessel passes the second pair of aligned markers the stopwatch is stopped.

Measuring a nautical mile

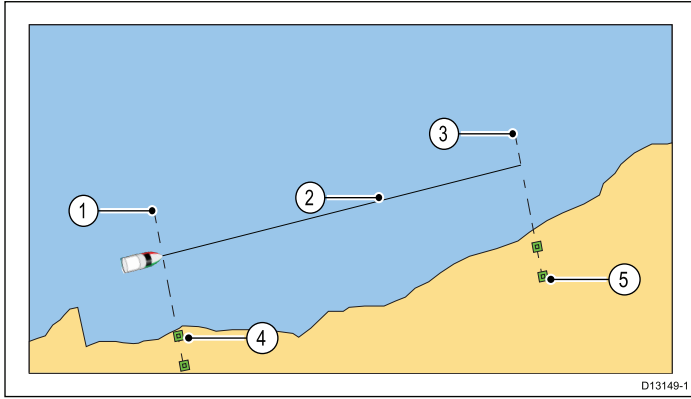

1. Starting point (start stopwatch)
2. Measured mile
3. End point (stop stopwatch)
4. First pair of markers
5. Second pair of markers

To provide a more accurate reading the vessel should make between 4 to 6 runs in both directions to allow for tide and wind conditions. The average of the time taken over all runs should be used to calculate Log Speed.

The vessel speed can then be worked out by taking the distance travelled (1 nautical mile) and dividing it by the average time taken to perform the run. The resulting calculation is your average speed in knots.

Performing a Speed Run Calibration using SOG

If a higher level of precision is required than that achieved with the 1 Point Speed Calibration procedure, a Speed Run Calibration should be performed. The Speed Run Calibration will ensure that the Log Speed reading is accurate over the vessel's full speed range.

Prerequisites:

- SOG data must be available.
- You will need to be underway, with sufficient space to maneuver unhindered.
- In order to achieve accurate results, water conditions must be calm with zero tide and zero current.

Note: Speed Run Calibration is not available when connected to a Speed Pod.

The steps below detail the method of calibrating:

- speed transducers connected via an iTC-5
- the speed element of a smart transducer connected directly to the SeaTalk^{ng} network.

From a favorite page:

1. Select **Menu**.
2. Select **Set-up**.
3. Select **Transducers Set-up**.
4. Select **Continue**.

The instrument display will search for and display a list of connected devices. (i.e. iTC-5, DST or transducer pod)

5. Select the device that the transducer(s) you are calibrating are connected to.

A list of available transducer data is displayed,

6. * Select **Speed**.

Note: * Step only applicable to iTC-5.

7. Select **Speed Calibration**.
8. Select **New cal using SOG**.

You will need to add calibration points at a range of speeds spanning the full speed range of the vessel. Conventional transducers can have up to 5 calibration points and smart transducers can have up to 8. Ideally the calibration points should be taken at regular increments throughout the speed range with the last calibration point being close to the vessel's top speed.

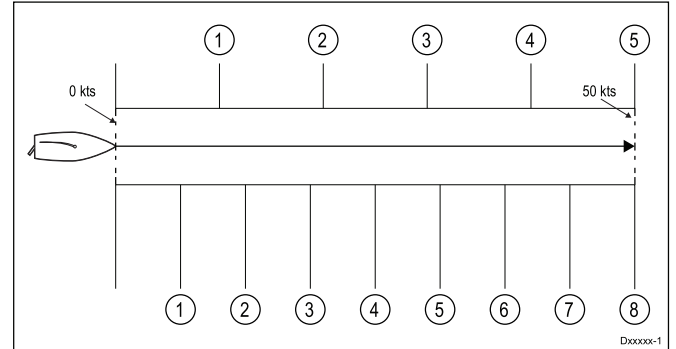

With the Speed Transducer connected to a Speed Pod the 5 calibration points are fixed in sequence at 2, 4, 8, 16 and 32 knots. When adding calibration points during the Speed Run Calibration ensure vessel speed is as close to the fixed calibration point speed as possible, as the calibration factor applied will be the difference between the actual vessel speed and the fixed calibration point speed.

9. Select **Start**.
 10. Ensure the vessel's speed is steady at your first calibration point speed and select **Add**.
 11. Repeat step 10 for all remaining calibration points, ensuring that the calibration points are equally spaced throughout your vessel's speed range from stationary to top speed.
- Once all calibration points have been successfully added the Calibration complete message is displayed.
12. Select **Ok**.

Calibration Table

By default Speed Transducers include a default set of calibration points which are overwritten during the normal speed calibration process. The calibration points are stored in the Calibration Table. The Calibration Table can be accessed from the Advanced Menu.

From the Advanced Menu you can:

- View the existing Calibration Table
- Adjust the existing calibration points (Add, Edit or Delete calibration points)
- Enter a new Calibration Table
- Check Log Speed against SOG
- Reset the Calibration Table to factory defaults

Viewing the calibration Table

Calibration points are stored in the Calibration Table.

From a favorite page:

1. Select **Menu**.
2. Select **Set-up**.
3. Select **Transducers Set-up**.
4. Select **Continue**.

The instrument display will search for and display a list of connected devices. (i.e. iTC-5, DST or transducer pod)

5. Select the device that the transducer(s) you are calibrating are connected to.

A list of available transducer data is displayed,

6. * Select **Speed**.

Note: * Step only applicable to iTC-5.

7. Select **Speed Calibration**.
8. Select **Advanced**.

9. Select **View cal table**.

The Calibration Table is displayed.

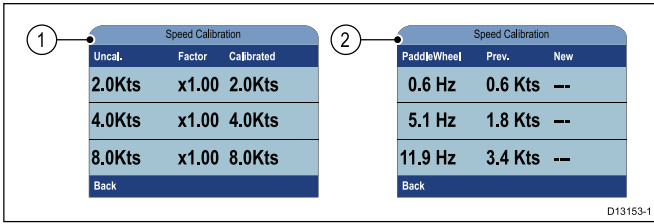

- Speed transducer connected via iTC-5 or speed pod.
 - Smart DST transducer connected directly to SeaTalk^{ng}.
10. Use the **Up** and **Down** buttons to scroll up and down through the table.
11. Select **Back** to return to the Advanced Menu.

Checking speed

The current speed can be checked at any time from the Advanced Menu.

From the Advanced Menu:

- Select **Check speed**.

The Check Speed page is displayed:

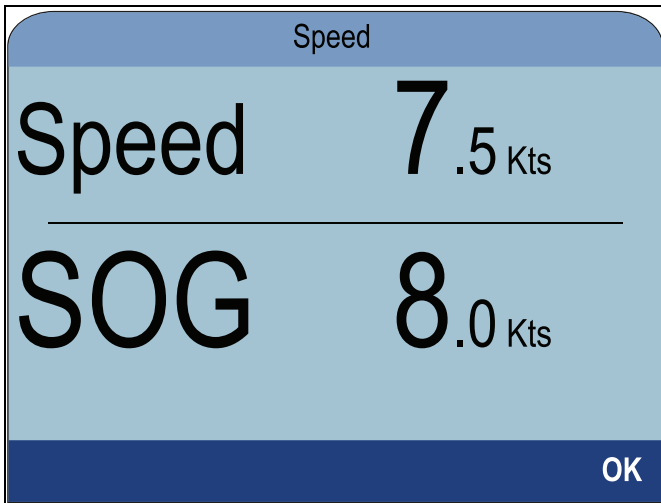

The Check Speed page can also be accessed from the Edit calibration options menu: **Advanced > Adjust cal table > Start > Options > Check speed**.

Manually working out a Calibration Factor

New Calibration Factors can be worked out manually following the steps below.

- You will need to be underway, with sufficient space to maneuver unhindered.
 - To ensure accuracy, water conditions should be calm with zero tide and zero current.
 - You will need to calibrate each calibration speed point, starting with the lowest
- In calm conditions with zero tide and zero current, run your vessel at a steady speed, approximately that of the selected calibration speed, over a measured distance.

Make a note of:

- The measured distance in nautical miles
 - The current speed value in knots
 - The time in minutes it takes to cover the measured distance
- Calculate the actual speed over the measured distance using the calculation: (Speed = (60 x Distance) / Time) The '60' is used to ensure the calculation is in minutes rather than hours or tenths of an hour.
e.g. Distance = 14 nautical miles, Time = 105 minutes (1 hour 45 minutes) so:

- $S = (60 \times D) / T$
- $S = (60 \times 14) / 105$
- $S = 840 / 105$
- $S = 8 \text{ Kts}$

3. If the calculated speed is:

- The same as the current speed, (noted during the Speed Run Calibration) then the calibration is correct at this speed so no action is required.
- Not the same as the current speed. Calculate a new, corrected Calibration Factor, as follows:
e.g. if actual speed equals 8 kts, indicated speed was 7.5 kts and the old Calibration Factor was 1.4 then:
 - new cal factor = actual speed x old factor / indicated speed
 - new cal factor = $8 \times 1.4 / 7.5$
 - new cal factor = $11.2 / 7.5$
 - new cal factor = 1.49

Adding a Calibration Point

Calibration Points can be manually added to the Calibration Table. The amount of Calibration Points that can be stored is determined by the type of speed transducer and method of connection.

From the Transducer found menu: **Menu > Set-up > Transducer set-up > Continue** :

- Select the device that the transducer(s) you are calibrating are connected to.
A list of available transducer data is displayed,
- * Select **Speed**.

Note: * Step only applicable to iTC-5.

- Select **Speed Calibration**.
 - Select **Advanced**.
 - Select **Adjust Calibration**.
 - Select **Start**.
- The current Calibration Table is displayed.
- Select the relevant Calibration Point from the table.
 - Select **Options**.
 - Select **Add cal point**.
 - Use the **Up** and **Down** buttons to adjust the displayed Log Speed to match SOG, if available or to match your estimated actual speed.
 - Select **Add**.
 - Select **Ok**.
 - Repeat steps 7 to 11 for each Calibration Point you want to add.

The more Calibration Points the higher the accuracy of Log Speed.

Note: If the text appears red then the new reading deviates too far from the stored reading. You will need to add a Calibration Point closer to the stored reading a try again.

Editing a Calibration Point

Existing Calibration Points can be manually edited.

From the Advanced Menu:

- Select **Adjust cal table**.
- Select **Start**.
- Highlight the relevant Calibration Point from the table.
- Select **Options**.
- Select **Edit cal point**.

The Calibration Point Adjustment page is displayed.

- Use the **Up** and **Down** buttons to adjust the Calibration Factor for the selected speed to match your new Calibration Factor.

7. Select **Done** to return to the Calibration Table.
8. Repeat steps 4 to 7 for all Calibration Points that require adjustment.
9. Select **Finish** when all of the required Calibration Points have been adjusted.

Deleting a Calibration Point

Calibration Points can be deleted from the Calibration Table.

From the Adjust cal table menu:

1. Select **Start**.
2. Highlight the Calibration Point you want to delete.
3. Select **Options**.
4. Select **Yes** to delete.

The Calibration Point is deleted from the Calibration Table.

Resetting the Calibration Table

The Calibration Table can be reset to factory default values by following the steps below:

From the Advanced Menu:

1. Select **Reset to defaults**.
2. Select **Yes**.
3. Select **Ok**.

The Calibration Table is reset to factory default values.

Entering a new Calibration Table

A new Calibration Table can be added manually. The new Calibration Table replaces the existing table which is deleted. This is useful when you have been provided a specific calibration table for your hull type.

Note: You will need to work out your Calibration Factors for each Calibration Point before you can create the new Calibration Table.

From the Advanced Menu:

1. Select **Enter new cal table**.
2. Select **Start**.

All existing Calibration Points are deleted and you will be prompted to enter new Calibration Points.

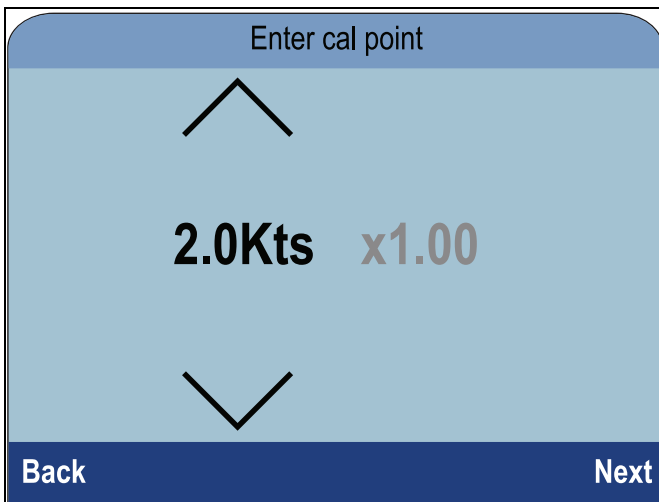

3. Use the **Up** and **Down** buttons to select the desired speed that you want to add a Calibration Point for.
4. Select **Next**.
5. Use the **Up** and **Down** buttons to adjust the Calibration Factor to the correct value.
6. Select **Done**.
7. Select **Add** to add the next Calibration Point.
8. Repeat steps 3 to 7 for all Calibration Points you want to add.
9. Select **Finish** when all Calibration Points have been added.
10. Select **OK**.

Calibrating Water Temperature

The Water Temperature reading can be calibrated as follows:

You will need an suitable thermometer to measure the Water Temperature.

From a favorite page:

1. Select **Menu**.
2. Select **Set-up**.
3. Select **Transducers Set-up**.
4. Select **Continue**.

The instrument display will search for and display a list of connected devices. (i.e. iTC-5, DST or transducer pod)

5. Select the device that the transducer(s) you are calibrating are connected to.

A list of available transducer data is displayed,

6. * Select **Speed**.

Note: * Step only applicable to iTC-5.

7. Select **Current Temperature** option.
8. Use a suitable thermometer to measure the actual water temperature.
9. Use the **Up** and **Down** buttons to match the displayed Water Temperature to the actual Water Temperature measured by the thermometer.
10. Select **Save** to save the setting.

Wind calibration

Calibrating wind

- You will need to be underway, with sufficient space to turn in a large slow circle unhindered.
- Conditions should be calm (i.e. a slight sea) and a steady breeze. Try to ensure the vessel is not rolling or pitching too much.

From a favorite page:

1. Select **Menu**.
2. Select **Set-up**.
3. Select **Transducers Set-up**.
4. Select **Continue**.

The instrument display will search for and display a list of connected devices. (i.e. iTC-5, DST or transducer pod)

5. Select the device that the transducer(s) you are calibrating are connected to.

A list of available transducer data is displayed,

6. * Select **Wind**.

Note: * Step only applicable to iTC-5.

7. Select **Calibrate Wind Xdcr**.
8. Keep the vessel speed below 2 kts and observing the screen, start to turn the vessel in a circle, then select **Start**.
9. Continue turning the vessel in circles until **Complete** is displayed on-screen.

If your rate of turn is too fast during calibration, a **Slow Down** message is displayed. If this happens, reduce your rate of turn this can be achieved by slowing down and / or steering in a wider circle.

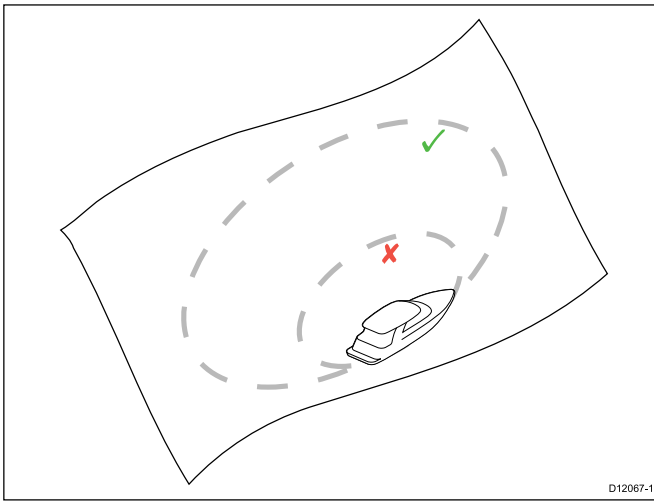

10. Select **Continue**.
 11. If required use the **UP** and **DOWN** buttons to manually adjust the vane offset.
 12. Press **SELECT** to complete the calibration process and save the settings.
- If required you can manually adjust each part of the calibration steps by selecting the relevant options from the **Wind** menu.

Aligning the wind transducer

- You will need to be underway, with sufficient space to turn in a large slow circle unhindered.
- Conditions should be calm (i.e. a slight sea) and a steady breeze. Try to ensure the vessel is not rolling or pitching too much.

From the list of transducers found:

1. Select the device that the transducer(s) you are calibrating are connected to.
- A list of available transducer data is displayed,
2. * Select **Wind**.

Note: * Step only applicable to iTC-5.

3. Select **Align Wind Xdcr**.
4. Now steer your vessel directly into the wind and select **Continue**.

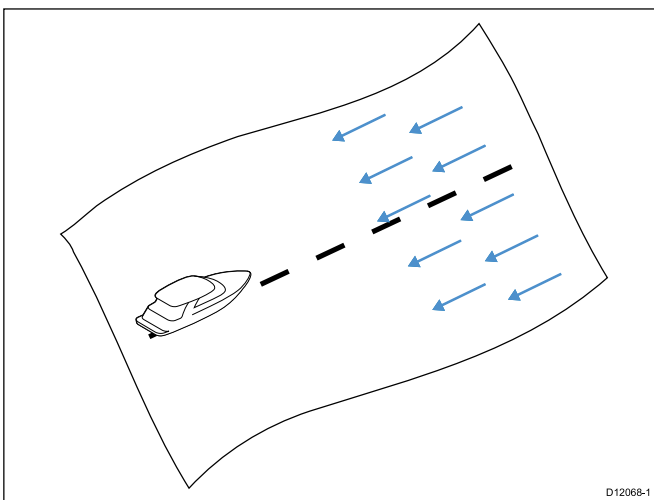

Adjusting the wind transducer

You can manually adjust the offset.

- You will need to be underway, with sufficient space to turn in a large slow circle unhindered.
- Conditions should be calm (i.e. a slight sea) and a steady breeze. Try to ensure the vessel is not rolling or pitching too much.

From the list of transducers found:

1. Steer your vessel directly into the wind

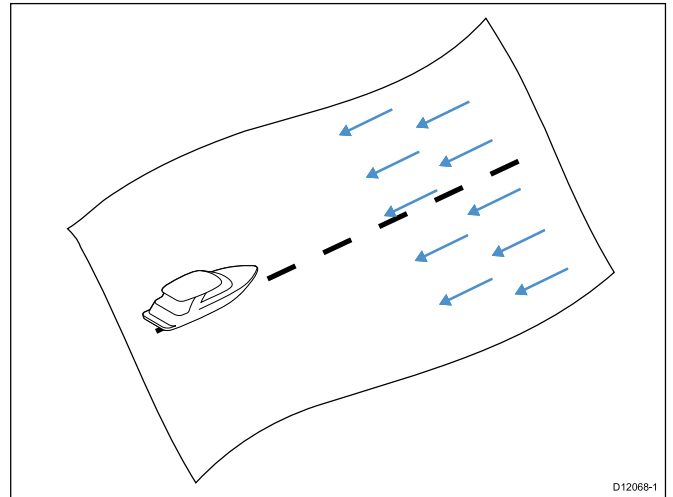

With your vessel sailing directly into the wind the Apparent Wind Angle (AWA) should be 0 degrees.

2. Select the device that the transducer(s) you are calibrating are connected to.

A list of available transducer data is displayed,

3. * Select **Wind**.

Note: * Step only applicable to iTC-5.

4. Select **Wind Xdcr Adjust**.

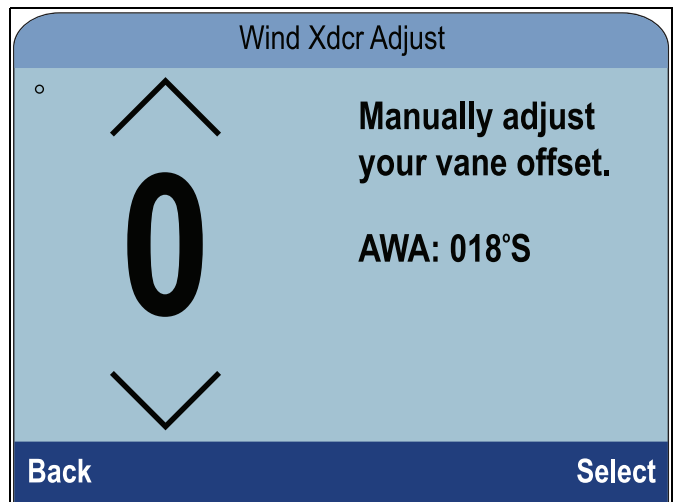

5. Use the **Up** and **Down** buttons to adjust the offset value so that the reported AWA is 0 degrees.

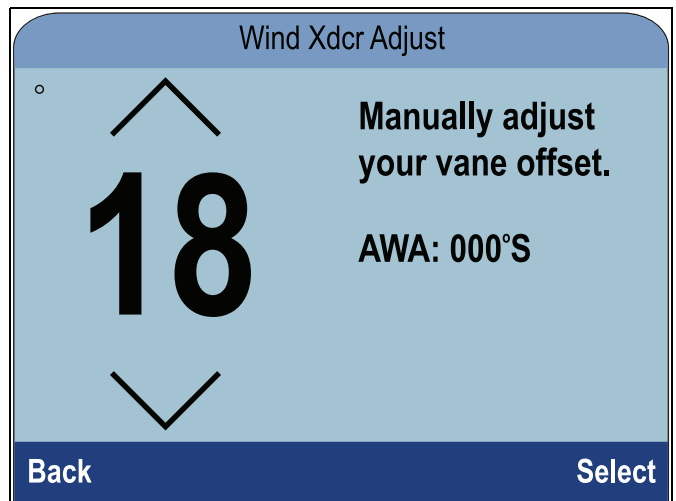

6. Select **Select**.

Adjusting apparent wind speed

To apply a Calibration Factor to the Apparent Wind Speed (AWS) reading follow the steps below.

- To apply an offset to your AWS readings an accurate reference for AWS must be used to compare the instrument's AWS reading against.
- Conditions should be calm (i.e. a slight sea) and a steady breeze. Try to ensure the vessel is not rolling or pitching too much.

From the list of transducers found:

1. Select the device that the transducer(s) you are calibrating are connected to.

A list of available transducer data is displayed,

2. * Select **Wind**.

Note: * Step only applicable to iTC-5.

3. Select **App Wind Speed**.

The AWS Calibration Factor page is displayed.

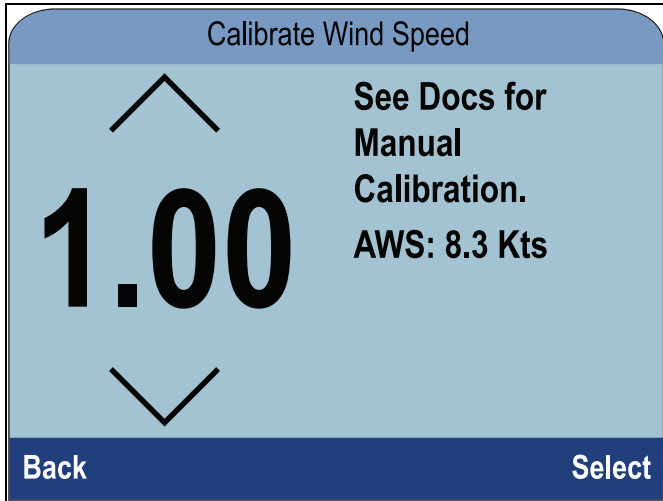

4. Use the **Up** and **Down** buttons to adjust the Calibration Factor until the AWS reading matches your referenced source of AWS.

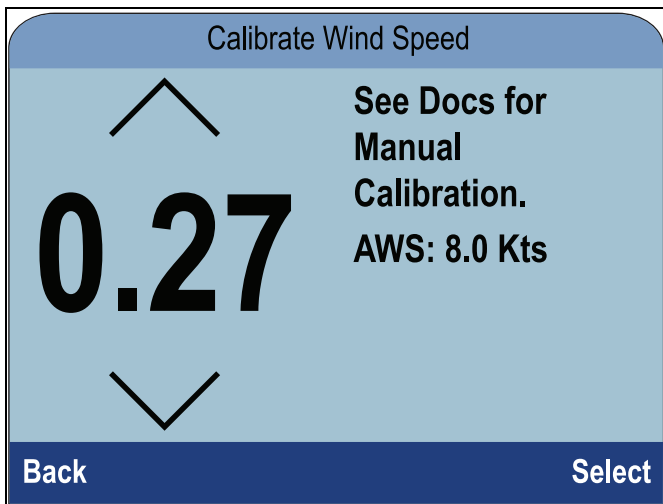

The Calibration Factor default is 1.00 the Calibration Factor can be adjusted from 0.25 to 2.00.

5. Select **Select** to save the Calibration Factor.

Rudder reference calibration

You can calibrate a rudder reference transducer that is connected to an iTC-5.

The rudder reference transducer must be connected to the rudder reference connection of the iTC-5 . Rudder reference transducers connected to an autopilot must be calibrated using the pilot controller.

Centering the Rudder

Centering the Rudder requires a method of knowing the Rudder's actual position.

From a favorite page:

1. Select **Menu**.
2. Select **Set-up**.
3. Select **Transducers Set-up**.
4. Select **Continue**.

The instrument display will search for and display a list of connected devices. (i.e. iTC-5, DST or transducer pod)

5. Select **iTC-5**.

A list of available transducer data is displayed,

6. Select **Rudder**.
7. Select **Centre Rudder**.

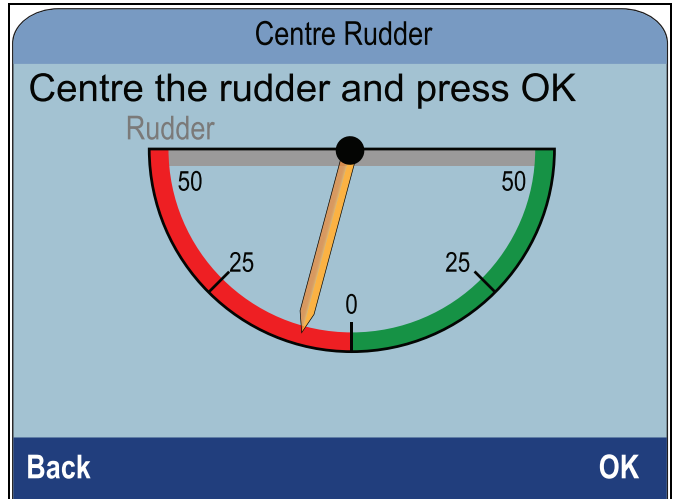

8. Turn the steering until the Rudder is centred.

The Rudder Reference has indicators on its base and on the rudder arm, ensure these marks are lined up.

9. With the Rudder centered, select **Ok**.

The pointer is zeroed on the display.

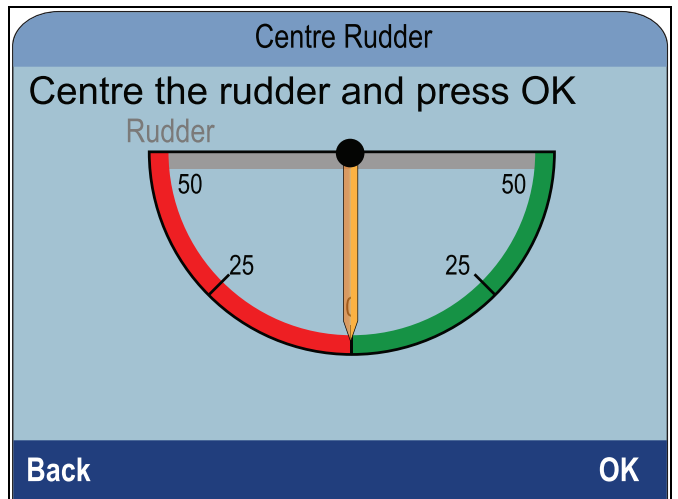

10. Select **Back** to return to the Rudder Calibration Menu.

Adjusting the Rudder Angle

You can manually adjust the Rudder Angle.

Manual adjustment of the Rudder Angle requires a method of knowing the Rudder's actual position.

From the transducers found page:

1. Ensure that the rudder is centered centred
2. Select **iTC-5**.

A list of available transducer data is displayed.

3. Select **Rudder**.

4. Select **Adjust Rudder Angle**.

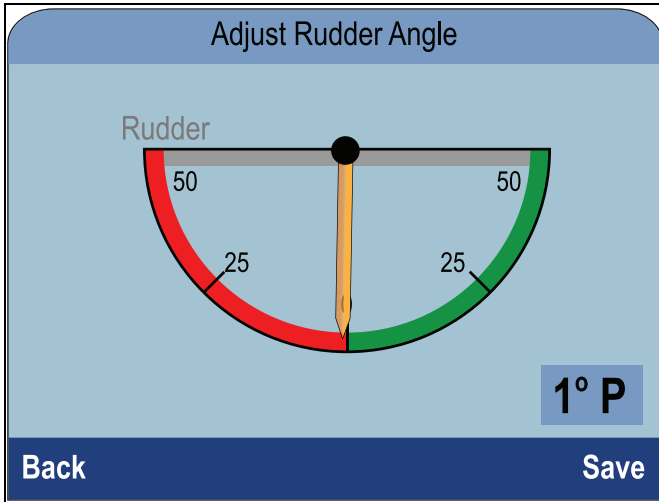

5. Use the **Up** and **Down** buttons to adjust the pointer so that the pointer and the reported Rudder Angles are both zero.
6. Select **Save**.

Inverting the Rudder

If the display's Rudder Pointer moves in the opposite direction (i.e. when you turn the Rudder starboard the pointer moves port) this can be corrected by inverting the Rudder.

From the transducers found page:

1. Ensure that the rudder is centred.
2. Select **iTC-5**.
A list of available transducer data is displayed.
3. Select **Rudder**.
4. Select **Invert Rudder Angle**.
5. If the pointer is pointed in the opposite direction than that expected, select **Invert**.

Compass calibration

You can calibrate a Fluxgate Compass that is connected to an iTC-5.

The compass must be connected to the compass connection of the iTC-5. Compasses connected to an autopilot must be calibrated using a Pilot Controller.

Swinging the Compass

You will need to turn your vessel in slow circles while the system automatically makes adjustments to account for Compass Deviation. Each 360-degree circle should take no less than two minutes, and you should complete at least two circles.

It is recommended that a second instrument display or MFD is used to display heading data, whilst performing the Compass Swing.

From a favorite page:

1. Select **Menu**.
2. Select **Set-up**.
3. Select **Transducers Set-up**.
4. Select **Continue**.

The instrument display will search for and display a list of connected devices. (i.e. iTC-5, DST or transducer pod)

5. Select **iTC-5**.

A list of available transducer data is displayed,

6. Select **Compass**.
7. Select **Swing Compass**.
8. Start moving vessel in slow even circles, then press **Start**.

9. Keep vessel speed to below 2 knots. Watch the display to ensure your turn rate is not too fast. If the message 'Slow Down — turn rate too fast' is displayed reduce your rate of turn, this can be achieved by slowing down and / or steering in a wider circle.

If the 'Slow Down — turn rate too fast' message is displayed the current circle will have to be repeated.

When the Compass has been calibrated, a message will be displayed showing the detected Compass Deviation.

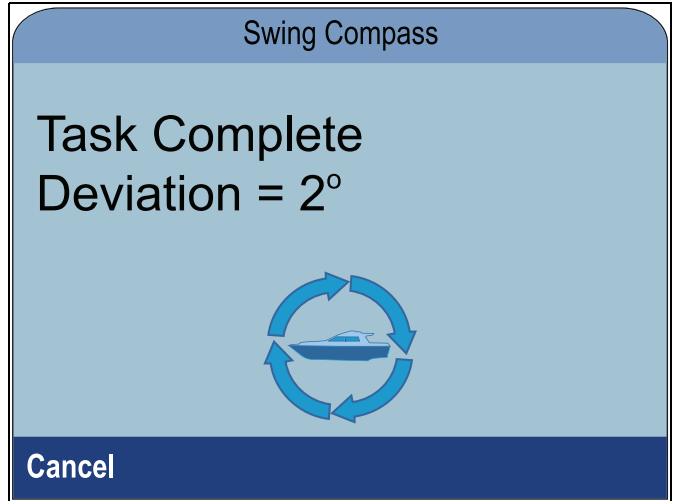

10. If the deviation is greater than 15 degrees you will need to relocate the Compass further away from metal items or items that may cause interference, then repeat the calibration process. If you still find a deviation of more than 15 degrees, contact your Raymarine dealer for advice. If the deviation is within acceptable limits, press **Cancel**.

Setting the Compass Offset

You can manually apply an offset to the Compass heading by following the steps below.

To apply an offset you require a source of heading such as the ship's compass.

From the transducers found page:

1. Ensure that the Rudder is centred
2. Select **iTC-5**.

A list of available transducer data is displayed.

3. Select **Compass**.
4. Select **Compass Offset**.
5. Steer your vessel on a steady course.
6. Use the **Up** and **Down** buttons to adjust the Compass Offset until the displayed heading matches the heading of the ship's compass.
7. Select **Save**.